



■ Features

- Output current level selectable by DIP S.W.
- 180~277VAC input only
- Built-in active PFC function
- Protections: Short circuit / Over temperature
- Cooling by free air convection
- Fully isolated plastic case
- Class II power unit, no FG
- Built-in 0~10VDC and PWM signal dimming function
- IP20 design
- No load power consumption <0.5W(Note.7)
- Power supplies synchronization function up to 10 units
- 3 years warranty

■ Applications

- Indoor LED lighting
- Office LED lighting
- LED decorative lighting

■ Description

LCM-25 is a 25Watts LED power supply that one single unit supplies multiple current levels, 350mA/500mA/ 600mA/700mA/900mA/1050mA. The current levels are easily switched by adjusting the built-in DIP switch. LCM-25 also provides the dimming function that control by external a 0~10VDC or PWM signal. Moreover, the synchronization design allows the dimming for up to 10 units of LCM-25 to be controlled simultaneously.

■ Model Encoding

LCM - 25





SPECIFICATION

MODEL		LCM-25					
OUTPUT	SELECTABLE CURRENT <small>Note.3</small>	350mA	500mA	600mA	700mA	900mA	1050mA
	DC VOLTAGE RANGE	6 ~ 54V	6 ~ 50V	6 ~ 42V	6 ~ 36V	6 ~ 28V	6 ~ 24V
	RATED POWER	18.9W	25.2W				
	RIPPLE CURRENT	±5.0%					
	RIPPLE & NOISE (max.) <small>Note.2</small>	400mVp-p					
	NO LOAD OUTPUT VOLTAGE (max.)	59V	41V				
	CURRENT ACCURACY	±5.0%					
	SETUP, RISE TIME <small>Note.5</small>	500ms, 50ms / 230VAC at full load					
	HOLD UP TIME (Typ.)	30ms / 230VAC at full load					
INPUT	VOLTAGE RANGE <small>Note.4</small>	180 ~ 277VAC	254 ~ 392VDC				
	FREQUENCY RANGE	47 ~ 63Hz					
	POWER FACTOR (Typ.)	PF ≥ 0.94/230VAC, PF ≥ 0.91/277VAC at full load (Please refer to "Power Factor Characteristic" curve)					
	TOTAL HARMONIC DISTORTION	THD < 20% when output loading ≥ 50% at 230VAC input and output loading ≥ 75% at 277VAC input					
	EFFICIENCY (Typ.) <small>Note.6</small>	86%					
	AC CURRENT (Typ.)	0.17A/230VAC	0.15A/277VAC				
	INRUSH CURRENT(max.)	COLD START 20A(twidth=260μs measured at 50% I _{peak}) at 230VAC					
	LEAKAGE CURRENT	< 0.5mA / 240VAC					
PROTECTION	SHORT CIRCUIT	Constant current limiting, recovers automatically after fault condition is removed					
	OVER TEMPERATURE	Shut down o/p voltage, recovers automatically after temperature goes down					
FUNCTION	DIMMING	Please see "Dimming Operation"					
	SYNCHRONIZATION	Please see "Synchronization Operation"					
ENVIRONMENT	WORKING TEMP.	-30 ~ +60°C (Refer to "Derating Curve")					
	WORKING HUMIDITY	20 ~ 90% RH non-condensing					
	STORAGE TEMP., HUMIDITY	-40 ~ +80°C, 10 ~ 95% RH					
	TEMP. COEFFICIENT	±0.03%/°C (0 ~ 50°C)					
	VIBRATION	10 ~ 500Hz, 2G 10min./1cycle, period for 60min. each along X, Y, Z axes					
SAFETY & EMC	SAFETY STANDARDS	UL8750, CSA C22.2 NO.250.0-08, ENEC EN61347-1, EN61347-2-13, EN62384 independent approved					
	WITHSTAND VOLTAGE	I/P-O/P:3.75KVAC ; I/P-DA ±:1.875VAC ; O/P-DA ±:1.875VAC					
	ISOLATION RESISTANCE	I/P-O/P:>100M Ohms / 500VDC / 25°C / 70% RH					
	EMC EMISSION	Compliance to EN55015, EN61000-3-2 Class C(≥ 50% load) ; EN61000-3-3					
	EMC IMMUNITY	Compliance to EN61000-4-2,3,4,5,6,8,11, EN55024, EN61547 light industry level (surge 2KV), criteria A					
OTHERS	MTBF	298.6K hrs min. MIL-HDBK-217F (25°C)					
	DIMENSION	105*68*23mm (L*W*H)					
	PACKING	0.16Kg ; 72pcs/12.5Kg/1.04CUFT					
NOTE	<ol style="list-style-type: none"> All parameters NOT specially mentioned are measured at 230VAC input, rated load and 25°C of ambient temperature. Ripple & noise are measured at 20MHz of bandwidth by using a 12" twisted pair-wire terminated with a 0.1uf & 47uf parallel capacitor. Please see "DIP switch table". Derating may be needed under low input voltage. Please check the static characteristics for more details. Length of set up time is measured at first cold start. Turning ON/OFF the power supply may lead to increase of the set up time. Efficiency is measured at 500mA/50V output set by DIP switch. No load power consumption<0.5W is measured at 230VAC, with lighting fixture connected and output current dimmed to 0%. The power supply is considered as a component that will be operated in combination with final equipment. Since EMC performance will be affected by the complete installation, the final equipment manufacturers must re-qualify EMC Directive on the complete installation again. 						

■ Block Diagram

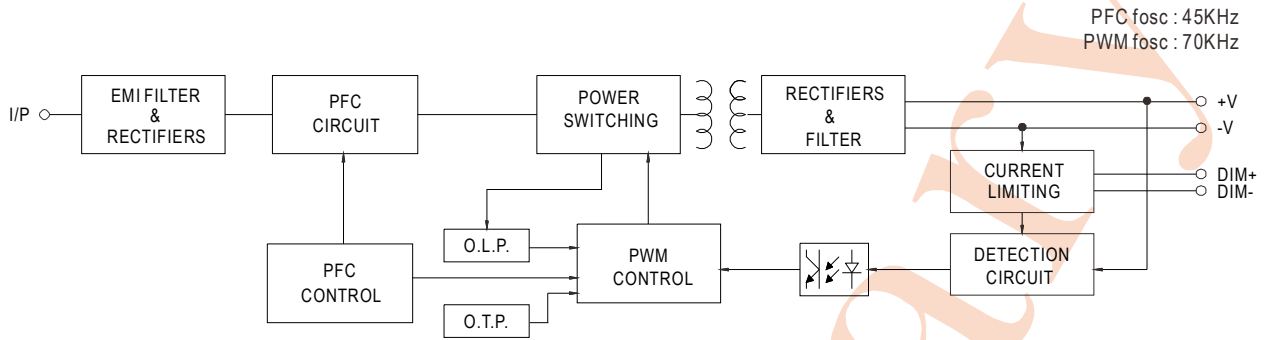

■ Derating Curve

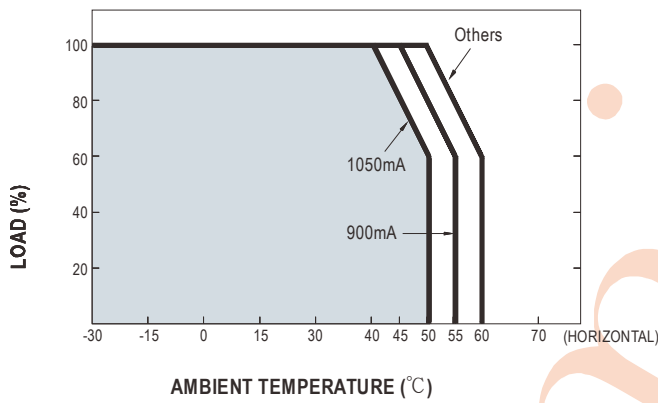

■ Static Characteristics

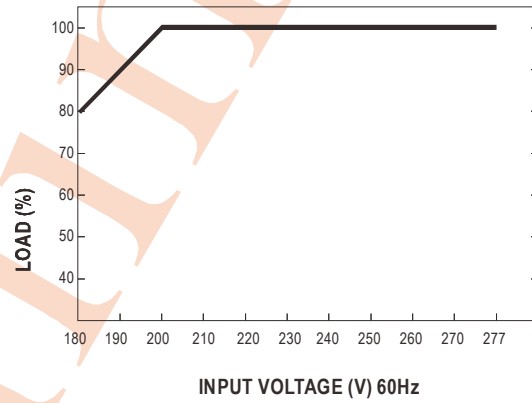

■ DIP Switch Table

LCM-25 is a multiple-stage output current supply, selection of output current through DIP switch as table below.

I _o	DIP S.W.					
	1	2	3	4	5	6
350mA	----	----	----	----	----	----
500mA	ON	----	----	----	----	----
600mA	ON	ON	----	----	----	----
700mA(Factory Setting)	ON	ON	ON	----	----	ON
900mA	ON	ON	ON	ON	----	ON
1050mA	ON	ON	ON	ON	ON	ON

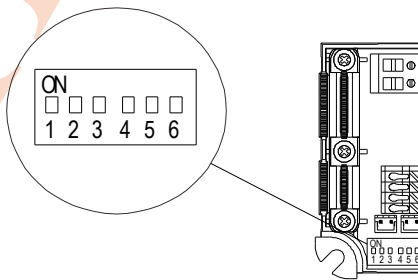

Power Factor Characteristic

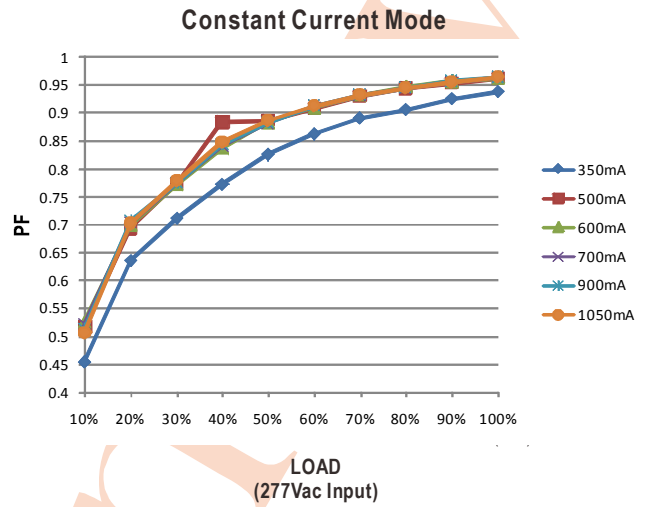
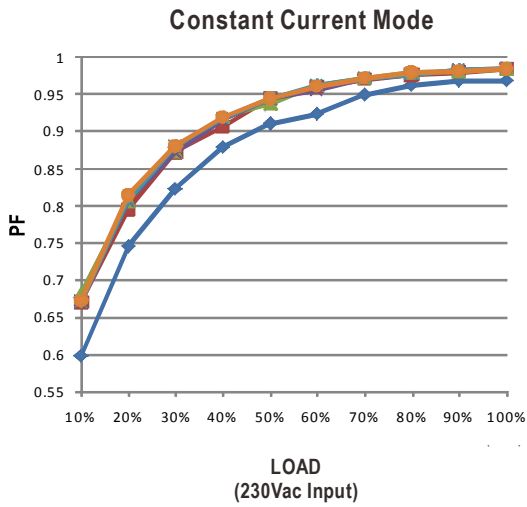

Total Harmonic Distortion Characteristic

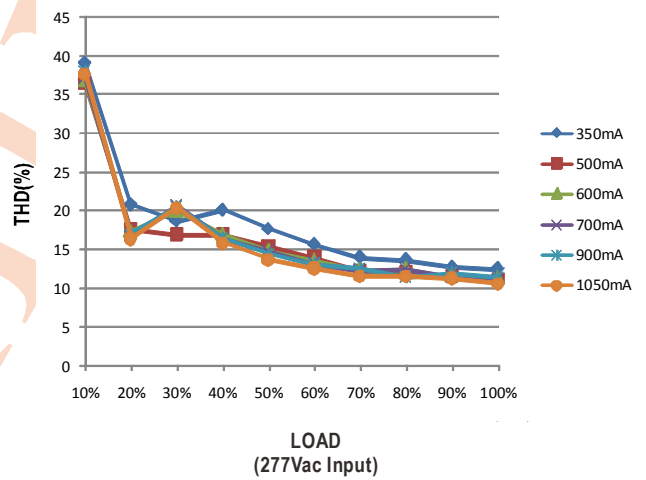
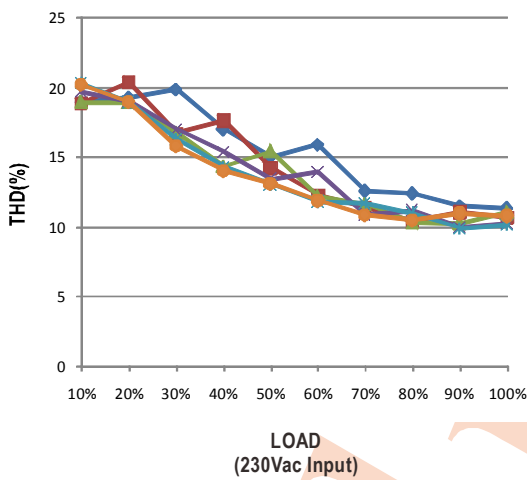

EFFICIENCY vs LOAD

LCM-25 possess superior working efficiency that up to 86% can be reached in field applications.

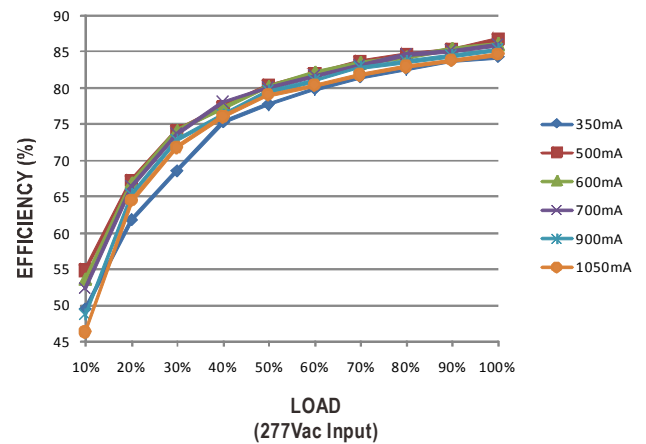
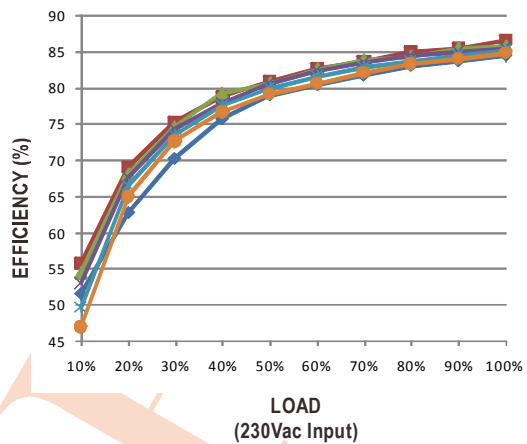

■ DIMMING OPERATION

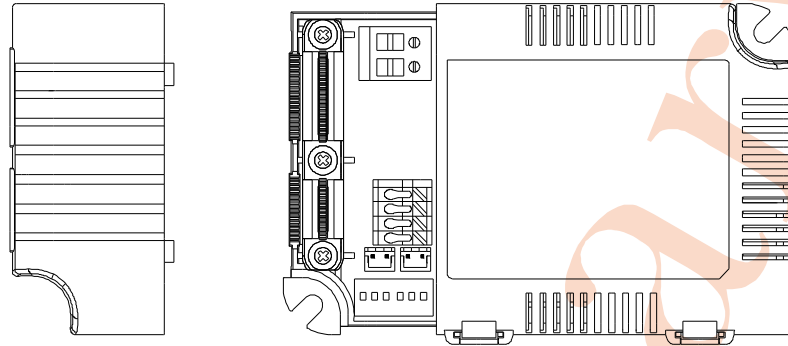

※ Built-in 2 in 1 dimming function, output constant current level can be adjusted through output terminal by 0 ~ 10Vdc or 10V PWM signal between DIM+ and DIM-.

※ Please DO NOT connect "DIM-" to "-Vo".

※ 0 ~ 10V dimming function for output current adjustment (Typical)

Dimming value	0V	1V	2V	3V	4V	5V	6V	7V	8V	9V	10V	OPEN
Output current	0%	10%	20%	30%	40%	50%	60%	70%	80%	90%	100%	100%~108%

※ 10V PWM signal for output current adjustment (Typical): Frequency range :100Hz ~ 3KHz

Duty value	0%	10%	20%	30%	40%	50%	60%	70%	80%	90%	100%	OPEN
Output current	0%	10%	20%	30%	40%	50%	60%	70%	80%	90%	100%	100%~108%

■ SYNCHRONIZATION OPERATION

- 10 drivers(max.) synchronization (1 master + 9 slaves).
- Maximum cable length between each units : 20 meters.
- Maximum cable length from the master unit to each end of the last slave units : 120 meters.
- The lights driven by LCM units(Slaves) can be dimmed synchronously through a LCM unit(the master) directly controlled via 0-10Vdc or 10V PWM dimming function. The wiring is shown as below.

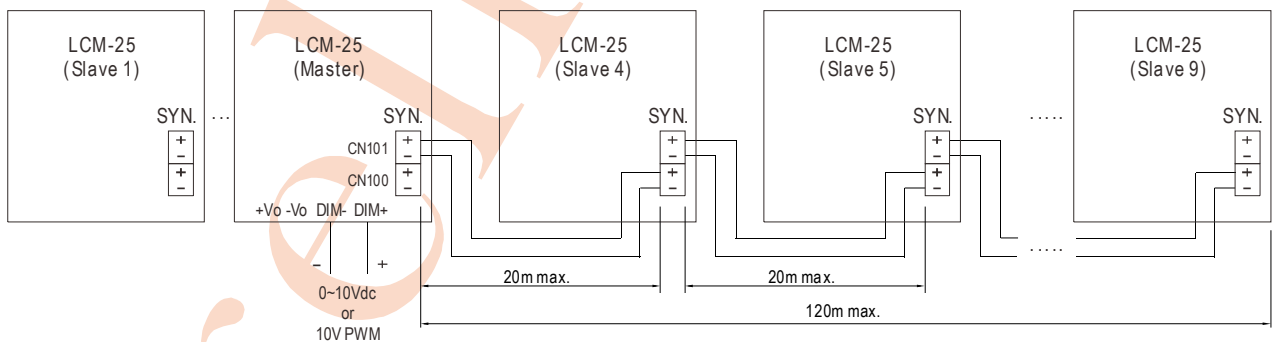

- CN100, CN101 : used to synchronously control the LCM units in parallel.

■ Mechanical Specification

Case No. LCM-25 Unit:mm

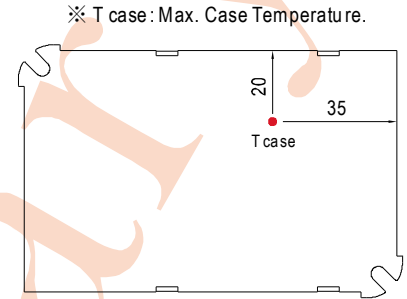
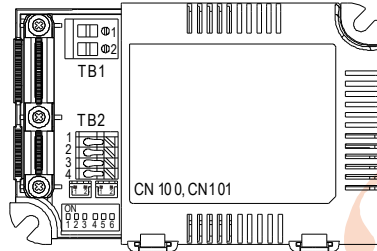
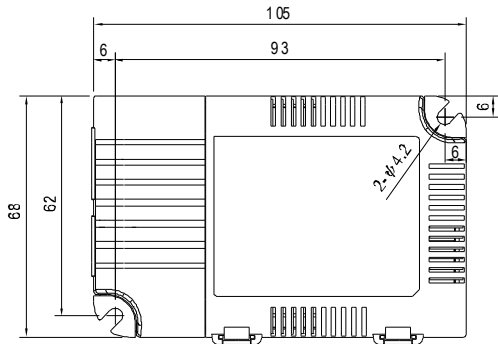

Bottom View

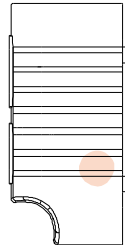
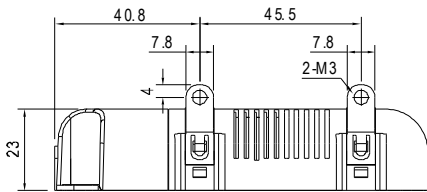

Terminal Pin No. Assignment(TB2)

Pin No.	Assignment	Pin No.	Assignment
1	+Vo	3	DIM-
2	-Vo	4	DIM+

Terminal Pin No. Assignment(TB1)

Pin No.	Assignment
1	AC/L
2	AC/N

SYN. Connector(CN100/CN101):JST B2B-PH-KL or equivalent

Pin No.	Assignment	Mating Housing	Terminal
1	-	JST PHR-2 or equivalent	JST SPH-002T-P0.5S or equivalent
2	+		

Note:Please use wires with 0.5~2.5mm²(13~20AWG) of cross-section for TB1 and wires with 0.5~1.5 mm²(16~20AWG) of cross -section for TB2.

■ Installation Manual

Please refer to : <http://www.meanwell.com/webnet/search/InstallationSearch.html>