

Dimension				
L	*	W	*	H
300	*	85	*	41 (1U) mm
11.8	*	3.35	*	1.61(1U) inch



■ Features

- Universal AC input / Full range
(Withstand 300VAC surge input for 5 seconds)
- Built-in active PFC function
- High efficiency up to 93%
- Forced air cooling by built-in DC fan
- Output voltage and constant current level programmable
- Active current sharing up to 9600W (5+1)
- Built-in remote ON-OFF control / remote sense / auxiliary power / DC OK signal / OTP alarm signal
- Protections: Short circuit / Overload / Over voltage / Over temperature
- Optional PMBus or CANBus protocol
- 5 years warranty

■ Applications

- Factory control or automation apparatus
- Test and measurement instrument
- Laser related machine
- Aging facility
- Digital broadcasting
- Constant current source
- Redundant system

■ Description

RSP-1600 is a 1.6KW single output enclosed type AC/DC power supply with a 1U low profile and a high power density up to 25W/inch³. This series operates for 90~264VAC input voltage and offers the models with the DC output mostly demanded from the industry. Each model is cooled by the thermostatically controlled fan. Moreover, RSP-1600 provides vast design flexibility by equipping various built-in functions such as the output programming, active current sharing, remote ON-OFF control, auxiliary power, etc.

■ Model Encoding / Order Information

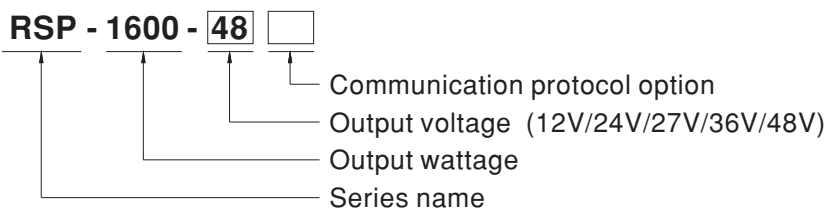

Type	Communication Protocol	Note
Blank	None	In Stock
PM	PMBus protocol	By request
CAN	CANBus protocol	By request

SPECIFICATION

MODEL	RSP-1600-12	RSP-1600-24	RSP-1600-27	RSP-1600-36	RSP-1600-48	
OUTPUT	DC VOLTAGE	12V	24V	27V	36V	48V
	RATED CURRENT	125A	67A	59A	44.5A	33.5A
	CURRENT RANGE	0 ~ 125A	0 ~ 67A	0 ~ 59A	0 ~ 44.5A	0 ~ 33.5A
	RATED POWER	1500W	1608W	1593W	1602W	1608W
	RIPPLE & NOISE (max.) Note.2	150mVp-p	200mVp-p	200mVp-p	250mVp-p	300mVp-p
	VOLTAGE ADJ. RANGE	11.5 ~ 15V	23.5 ~ 30V	26.5 ~ 33.5V	35.5 ~ 45V	47.5 ~ 58.8V
	VOLTAGE TOLERANCE Note.4	±1.0%	±1.0%	±1.0%	±1.0%	±1.0%
	LINE REGULATION	±0.5%	±0.5%	±0.5%	±0.5%	±0.5%
	LOAD REGULATION	±0.5%	±0.5%	±0.5%	±0.5%	±0.5%
	SETUP, RISE TIME	1500ms, 60ms/230VAC at full load				
HOLD UP TIME (Typ.)	16ms / 230VAC at 75% load		10ms / 230VAC at full load			
INPUT	VOLTAGE RANGE Note.5	90 ~ 264VAC 127 ~ 370VDC				
	FREQUENCY RANGE	47 ~ 63Hz				
	POWER FACTOR (Typ.)	0.97/230VAC at full load				
	EFFICIENCY (Typ.)	89%	91.5%	92%	92%	93%
	AC CURRENT (Typ.) Note.5	14A/115VAC 8A/230VAC	15A/115VAC 8.5A/230VAC			
	INRUSH CURRENT (Typ.)	COLD START 35A/230VAC				
	LEAKAGE CURRENT	<2mA / 230VAC				
PROTECTION	OVERLOAD	105 ~ 115% rated output power Protection type : Constant current limiting, unit will shut down o/p voltage after 5 sec. re-power on to recover				
	OVER VOLTAGE	15.75 ~ 18.75V	31.5 ~ 37.5V	35.2 ~ 41.9V	47.2 ~ 56.3V	63 ~ 75V
	OVER TEMPERATURE	Protection type : Shut down o/p voltage, re-power on to recover Protection type : Shut down o/p voltage, recovers automatically after temperature goes down				
FUNCTION	OUTPUT VOLTAGE PROGRAMMABLE(PV) Note 6	Adjustment of output voltage is allowable to 40 ~ 125% of nominal output voltage (60 ~ 125% for 12V). Please refer to the Function Manual.				
	OUTPUT CURRENT PROGRAMMABLE(PC) Note 6	Adjustment of constant current level is allowable to 20 ~ 100% of rated current. Please refer to the Function Manual.				
	AUXILIARY POWER	5V @ 0.3A, 12V @ 0.8A				
	REMOTE ON-OFF CONTROL	By electrical signal or dry contact Power ON:short Power OFF:open. Please refer to the Function Manual				
	REMOTE SENSE	Compensate voltage drop on the load wiring up to 0.5V. Please refer to the Function Manual				
ENVIRONMENT	ALARM SIGNAL	Isolated signal output for T-alarm and DC OK				
	WORKING TEMP.	-30 ~ +70°C (Refer to "Derating Curve")				
	WORKING HUMIDITY	20 ~ 90% RH non-condensing				
	STORAGE TEMP., HUMIDITY	-40 ~ +85°C, 10 ~ 95% RH non-condensing				
	TEMP. COEFFICIENT	±0.03%/°C (0 ~ 50°C)				
SAFETY & EMC (Note 7)	VIBRATION	10 ~ 500Hz, 2G 10min./1cycle, 60min. each along X, Y, Z axes				
	SAFETY STANDARDS	UL60950-1, TUV EN60950-1, EAC TP TC 004, BSMI CNS14336-1 approved				
	WITHSTAND VOLTAGE	I/P-O/P:3KVAC I/P-FG:2KVAC O/P-FG:1.5KVAC				
	ISOLATION RESISTANCE	I/P-O/P, I/P-FG, O/P-FG:100M Ohms / 500VDC / 25°C / 70% RH				
	EMC EMISSION	Parameter	Standard		Test Level / Note	
		Conducted	EN55032 (CISPR32) / EN55011 (CISPR11)		Class B	
		Radiated	EN55032 (CISPR32) / EN55011 (CISPR11)		Class A	
		Harmonic Current	EN61000-3-2		Class A	
		Voltage Flicker	EN61000-3-3		-----	
	EMC IMMUNITY	EN55024 , EN61204-3, EN61000-6-2, BSMI CNS13438				
		Parameter	Standard		Test Level / Note	
		ESD	EN61000-4-2		Level 3, 8KV air ; Level 2, 4KV contact	
Radiated		EN61000-4-3		Level 3		
EFT / Burst		EN61000-4-4		Level 3		
Surge		EN61000-4-5		Level 4, 2KV/Line-Line 4KV/Line-Earth		
Conducted		EN61000-4-6		Level 3		
Magnetic Field		EN61000-4-8		Level 4		
Voltage Dips and Interruptions	EN61000-4-11		>95% dip 0.5 periods, 30% dip 25 periods, >95% interruptions 250 periods			
OTHERS	MTBF	160.9K hrs min. Telcordia SR-332 (Bellcore) ; 42.1K hrs min. MIL-HDBK-217F (25°C)				
	DIMENSION	300*85*41mm (L*W*H)				
	PACKING	2.1Kg;6pcs/13.6Kg/1.03CUFT				
NOTE	<p>1. All parameters NOT specially mentioned are measured at 230VAC input, rated load and 25°C of ambient temperature.</p> <p>2. Ripple & noise are measured at 20MHz of bandwidth by using a 12" twisted pair-wire terminated with a 0.1uF & 47uF parallel capacitor.</p> <p>3. Under parallel operation ripple of the output voltage may be higher than the SPEC at light load condition. It will go back to normal ripple level once the output load is more than 5%.</p> <p>4. Tolerance : includes set up tolerance, line regulation and load regulation.</p> <p>5. Derating may be needed under low input voltages. Please check the derating curve for more details.</p> <p>6. PV/PC functions when users are not operating on PMBus/CANBus. SVR functions when users are neither operating on PMBus/CANBus nor using PV/PC.</p> <p>7. The power supply is considered a component which will be installed into a final equipment. All the EMC tests are been executed by mounting the unit on a 720mm*360mm metal plate with 1mm of thickness. The final equipment must be re-confirmed that it still meets EMC directives. For guidance on how to perform these EMC tests, please refer to "EMI testing of component power supplies." (as available on http://www.meanwell.com)</p> <p>8. The ambient temperature derating of 3.5°C/1000m with fanless models and of 5°C/1000m with fan models for operating altitude higher than 2000m(6500ft).</p>					

Block Diagram

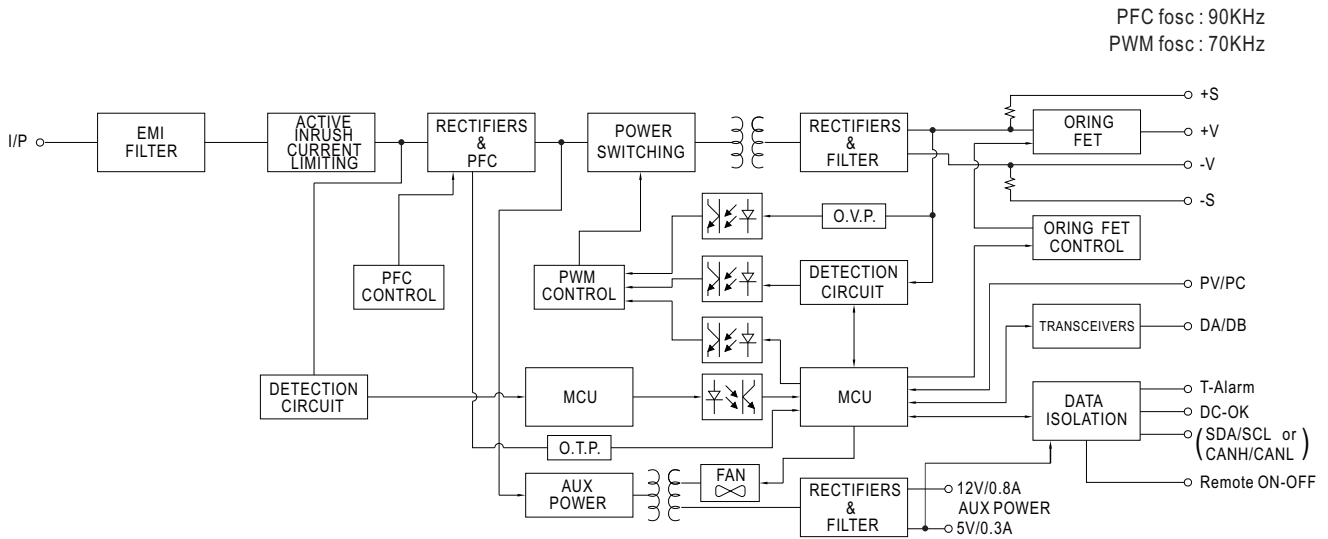

Static Characteristics

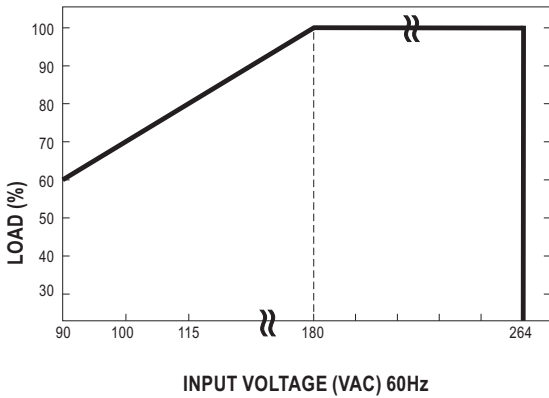

INPUT \ MODEL	12V	24V	27V	36V	48V
180~264VAC	1500W 125A	1608W 67A	1593W 59A	1602W 44.5A	1608W 33.5A
115VAC	1200W 100A	1286.4W 53.6A	1274.4W 47.2A	1281.6W 35.6A	1286.4W 26.8A
100VAC	1050W 87.5A	1125.6W 46.9A	1115.1W 41.3A	1121.4W 31.15A	1125.6W 23.45A
90VAC	900W 75A	964.8W 40.2A	955.8W 35.4A	961.2W 26.7A	964.8W 20.1A

Derating Curve

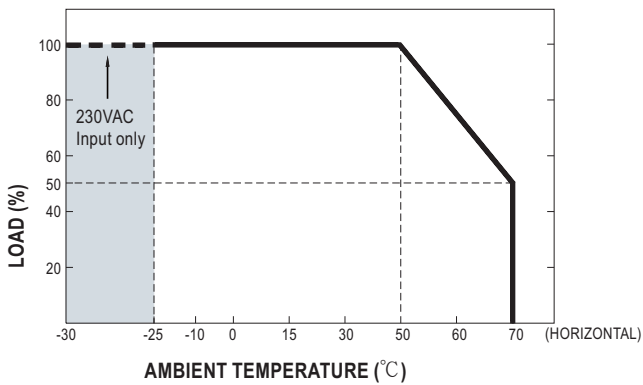

Efficiency vs Load (48V Model)

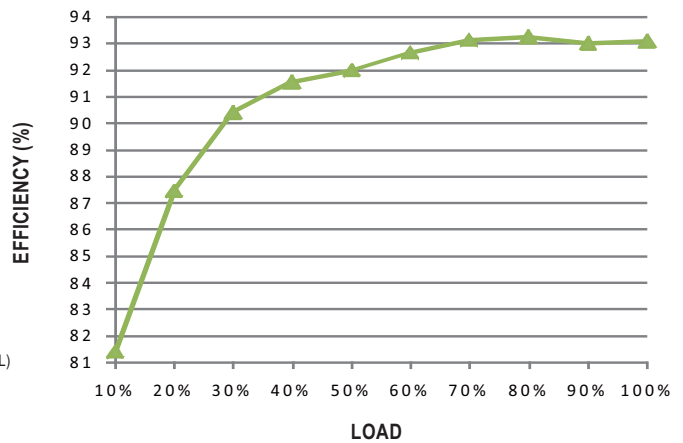

© The curve above is measured at 230VAC.

■ Function Manual

1. Voltage Drop Compensation

1.1 Remote Sense

※ The Remote Sense compensates voltage drop on the load wiring up to 0.5V

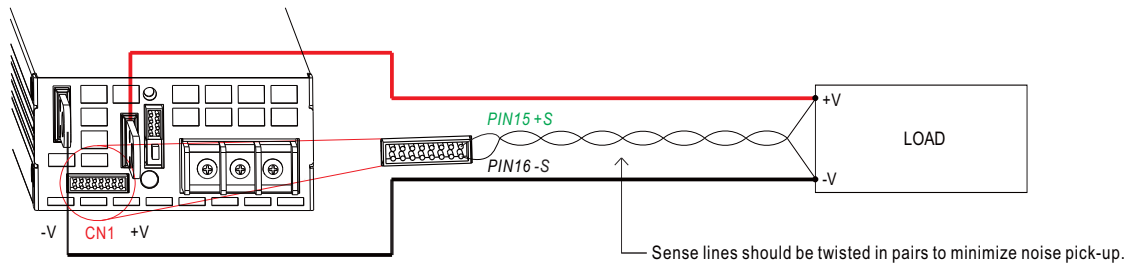

◎ The +S signal should be connected to the positive terminal of the load whereas -S signal to the negative terminal.

1.2 Local Sense

※ The +S,-S have to be connected to the +V(signal), -V(signal), respectively, as the following diagram, in order to get the correct output voltage if Remote Sense is not used.

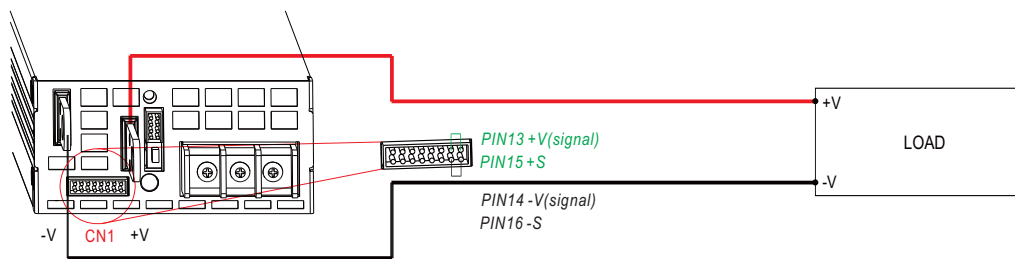

2. Output Voltage Programming (or, PV / remote voltage programming / remote adjust / margin programming / dynamic voltage trim)

※ In addition to the adjustment via the built-in potentiometer, the output voltage can be trimmed by applying EXTERNAL VOLTAGE.

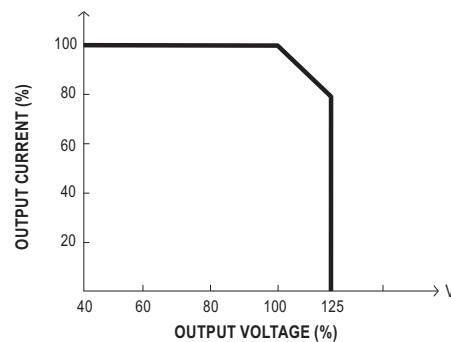
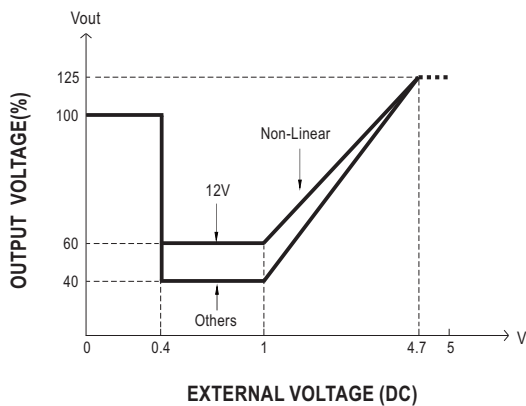
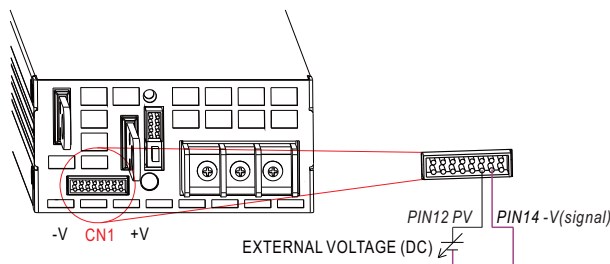

◎ The rated current should change with the Output Voltage Programming accordingly.

◎ For Remote Sense / Local Sense, please refer to "Voltage Drop Compensation" section.

3. Constant Current Level Programming (or, PC / remote current programming / dynamic current trim)

※ The constant current level can be trimmed to 20~100% of the rated current by applying EXTERNAL VOLTAGE.

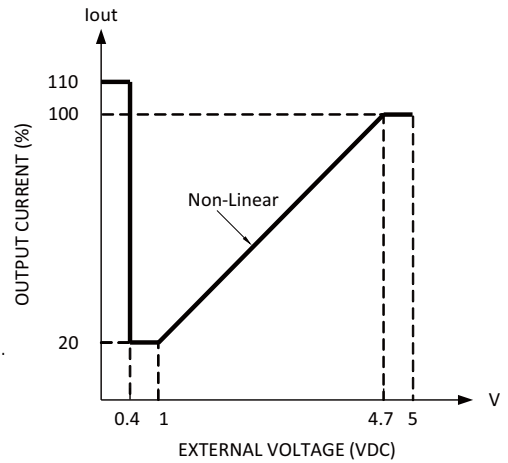
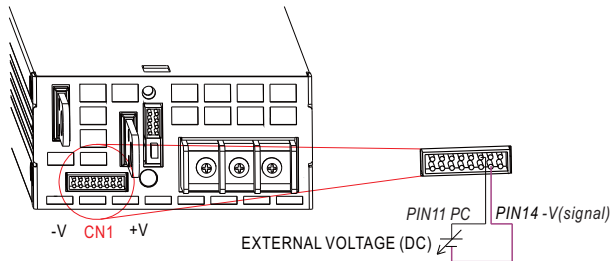

◎ For Remote Sense / Local Sense, please refer to "Voltage Drop Compensation" section.

4. Remote ON-OFF Control

※ The power supply can be turned ON/OFF individually or along with other units by using the "Remote ON-OFF" function.

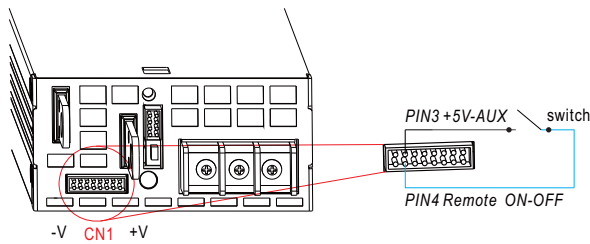

Between Remote ON-OFF and +5V-AUX	Power Supply Status
Switch Short	ON
Switch Open	OFF

5. Alarm Signal Output

※ There are 2 alarm signals, DC OK and T-ALARM, in TTL signal form, on CN1. These signals are isolated from output. The maximum sink current is 10mA.

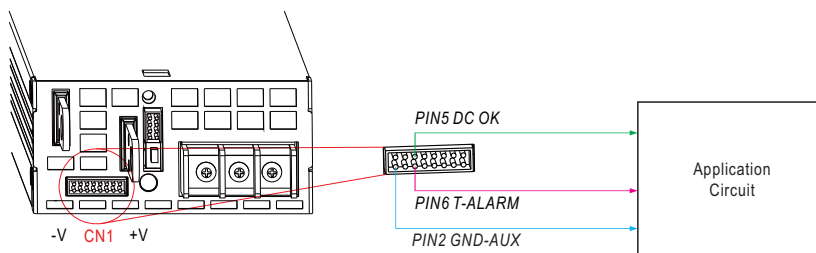

6. Current Sharing with Remote Sense

RSP-1600 has the built-in active current sharing function and can be connected in parallel, up to 6 units, to provide higher output power as exhibited below :

- ※ The power supplies should be paralleled using short and large diameter wiring and then connected to the load.
- ※ Difference of output voltages among parallel units should be less than 0.2V.
- ※ The total output current must not exceed the value determined by the following equation:

$$\text{Maximum output current at parallel operation} = (\text{Rated current per unit}) \times (\text{Number of unit}) \times 0.9$$
- ※ When the total output current is less than 5% of the total rated current, or say $(5\% \text{ of Rated current per unit}) \times (\text{Number of unit})$ the current shared among units may not be balanced.
- ※ Under parallel operation ripple of the output voltage may be higher than the SPEC at light load condition. It will go back to normal ripple level once the output load is more than 5%.
- ※ CN500/SW1 Function pin connection

Parallel	PSU1		PSU2		PSU3		PSU4		PSU5		PSU6	
	CN500	SW1	CN500	SW1	CN500	SW1	CN500	SW1	CN500	SW1	CN500	SW1
1 unit	X	ON	—	—	—	—	—	—	—	—	—	—
2 unit	V	ON	V	ON	—	—	—	—	—	—	—	—
3 unit	V	ON	V	OFF	V	ON	—	—	—	—	—	—
4 unit	V	ON	V	OFF	V	OFF	V	ON	—	—	—	—
5 unit	V	ON	V	OFF	V	OFF	V	OFF	V	ON	—	—
6 unit	V	ON	V	OFF	V	OFF	V	OFF	V	OFF	V	ON

(V : CN500 connected ; X : CN500 not connected.)

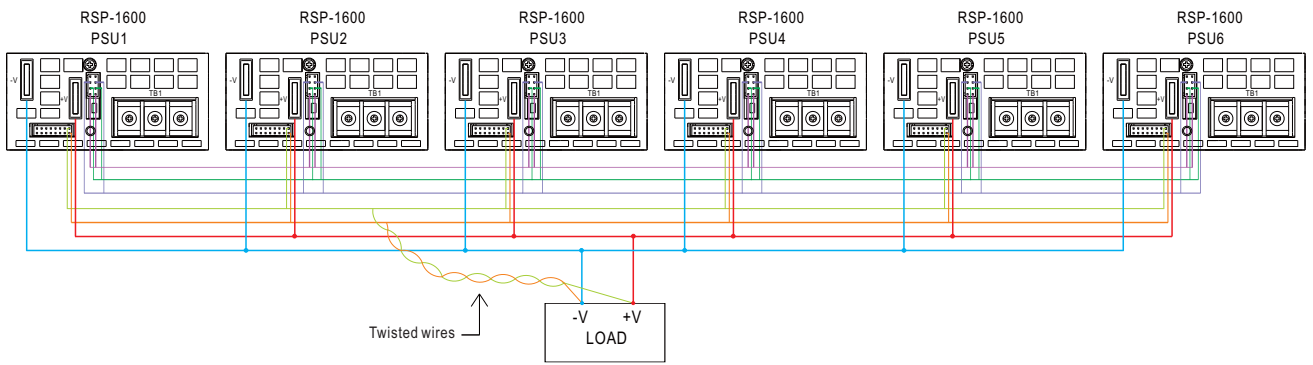
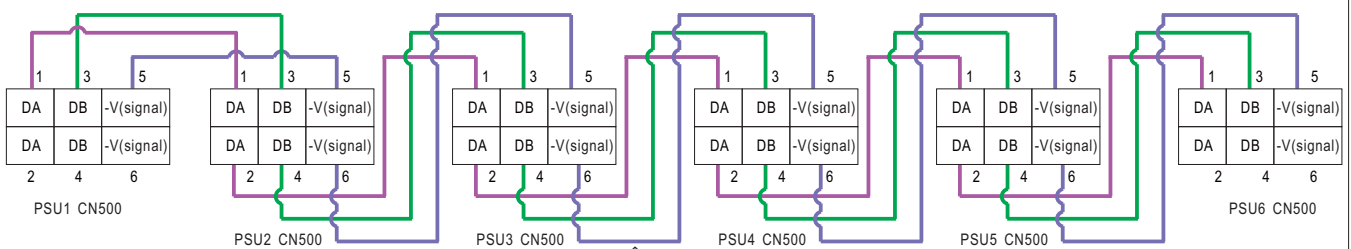

Fig 5.1



If the lines of CN500 are too long, they should be twisted in pairs to avoid the noise.

- ◎ DA, DB and -V(signal) are connected mutually in parallel.
- ◎ For Remote Sense / Local Sense, please refer to "Voltage Drop Compensation" section.

■ Mechanical Specification

Case No.250 Unit:mm

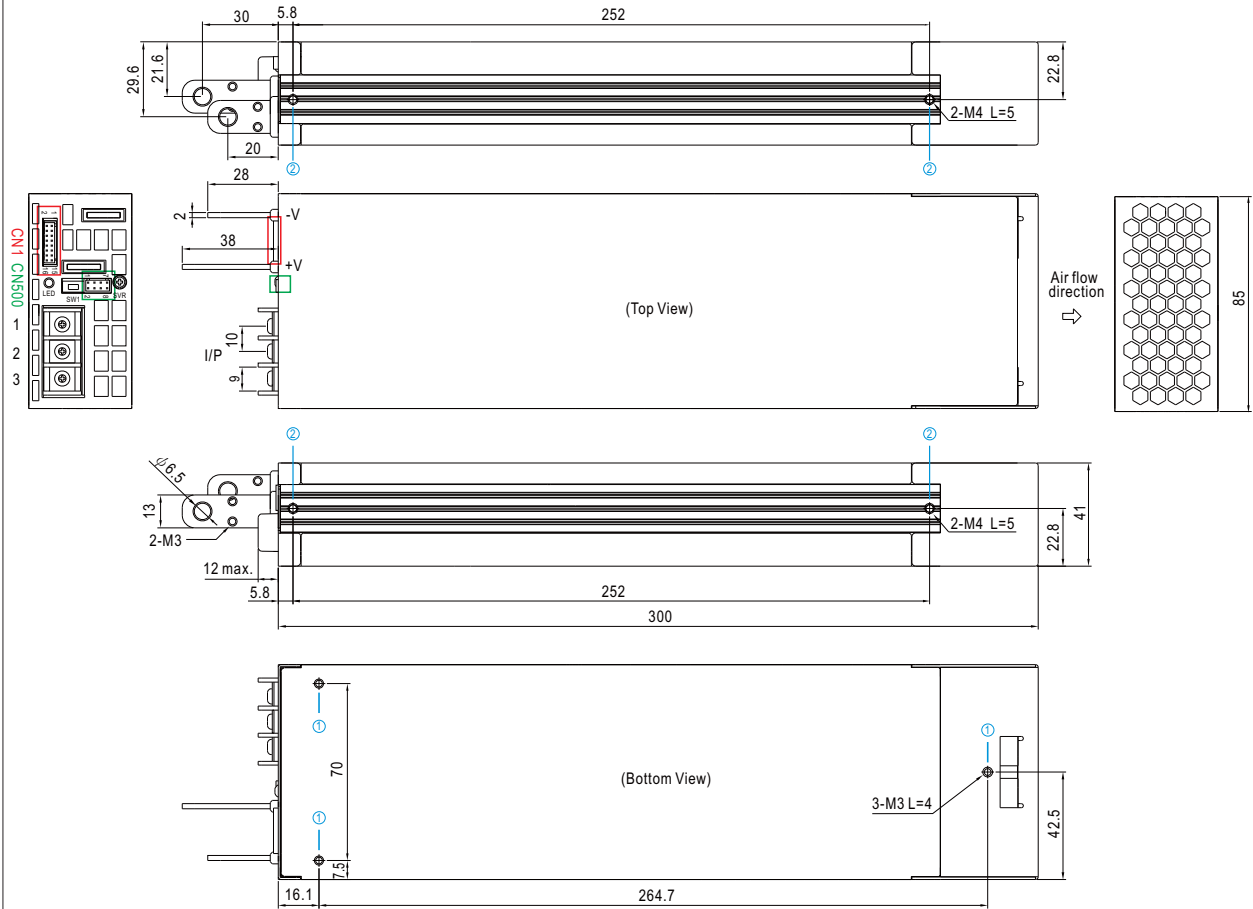

※ Mounting Instruction

Hole No.	Recommended Screw Size	MAX. Penetration Depth L	Recommended mounting torque
①	M3	6mm	6~8Kgf-cm
②	M4	7mm	7~10Kgf-cm

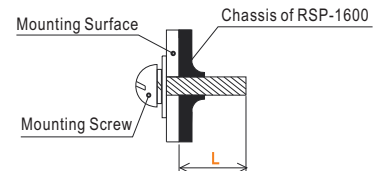

※ Control Pin No. Assignment(CN1) : HRS DF11-16DP-2DS or equivalent

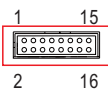



Mating Housing	HRS DF11-16DS or equivalent
Terminal	HRS DF11-**SC or equivalent

Pin No.	Function	Description
1	+12V-AUX	Auxiliary voltage output, 10.6~13.2V, referenced to GND-AUX (pin2). The maximum load current is 0.8A. This output has the built-in "Oring diodes" and is not controlled by "Remote ON-OFF".
2	GND-AUX	Auxiliary voltage output GND. The signal return is isolated from the output terminals (+V & -V).
3	+5V-AUX	Auxiliary voltage output, 4.5~5.5V, referenced to GND-AUX (pin2). The maximum load current is 0.3A. This output has the built-in "Oring diodes" and is not controlled by "Remote ON-OFF".
4	Remote ON-OFF	The unit can turn the output ON/OFF by electrical signal or dry contact between <i>Remote ON/OFF</i> and +5V-AUX. (Note.2) Short (4.5 ~ 5.5V) : Power ON ; Open (0 ~ 0.5V) : Power OFF ; The maximum input voltage is 5.5V.
5	DC-OK	High (4.5 ~ 5.5V) : When the $V_{out} \leq 80\% \pm 5\%$. Low (-0.1 ~ 0.5V) : When $V_{out} \geq 80\% \pm 5\%$. The maximum sourcing current is 10mA and only for output. (Note.2)
6	T-ALARM	High (4.5 ~ 5.5V) : When the internal temperature exceeds the limit of temperature alarm, or when Fan fails. Low (-0.1 ~ 0.5V) : When the internal temperature is normal, and when Fan normally works. The maximum sourcing current is 10mA and only for output.(Note.2)
7,8,9	NC	For standard model: Retain for future use. For PMBus / CANBus model: PMBus / CANBus interface address lines. (Note.1)
10	NC	Retain for future use.
11	PC	Connection for constant current level programming. (Note.1)
12	PV	Connection for output voltage programming. (Note.1)
13	+V (Signal)	Positive output voltage signal. It is for local sense; it cannot be connected directly to the load.
14	-V (Signal)	Negative output voltage signal. It is for local sense and certain function reference; it cannot be connected directly to the load.
15	+S	Positive sensing for remote sense.
16	-S	Negative sensing for remote sense.

Note.1: Non-isolated signal, referenced to [-V(signal)].

Note.2: Isolated signal, referenced to GND-AUX.

※ LED Status Indicators

LED	Description
 Green	The power supply functions normally.
 Red	Abnormal status (Over temperature protection, Overload protection, Fan fail.)

※ AC Input Terminal Pin No. Assignment

Pin No.	Assignment	Diagram	Maximum mounting torque
1	FG \perp		8Kgf-cm
2	AC/N		
3	AC/L		

※ Control Pin No. Assignment(CN500) : HRS DF11-8DP-2DS or equivalent

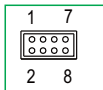

Mating Housing	HRS DF11-8DS or equivalent
Terminal	HRS DF11-**SC or equivalent

Pin No.	Function	Description
1,2	DA	Differential digital signal for parallel control.
3,4	DB	Differential digital signal for parallel control.
5,6	-V (Signal)	Negative output voltage signal. It is for certain function reference; it cannot be connected directly to the load.
7	NC	For standard model: None.
	SDA	For PMBus model: Serial Data used in the PMBus interface. (Note)
8	CANH	For CANBus model: Data line used in CANBus interface. (Note)
	NC	For standard model: None.
	SCL	For PMBus model: Serial Clock used in the PMBus interface. (Note)
	CANL	For CANBus model: Data line used in CANBus interface. (Note)

Note: Isolated signal, referenced to GND-AUX.

※ Control Pin No. Assignment(SW1)

Pin No.	Function	Description
1,2	Terminal resistance	SW1 is the selector of terminal resistor that is designed for DA/DB signals and parallel control function.

■ Installation Manual

Please refer to : <http://www.meanwell.com/manual.html>