



Test Report: RST-10000-48

10000W Single Output Power Supply

DESIGN VERIFY TEST

Output Function Test

Input Function Test

Protection Function Test

Control Function Test

Component Stress Test

SAFETY & E.M.C. TEST

Safety Test

E.M.C. Test

RELIABILITY TEST

ENVIRONMENT TEST

OUTPUT FUNCTION TEST

NO	TEST ITEM	SPECIFICATION	TEST CONDITION	RESULT
1	OUTPUT VOLTAGE ADJUST RANGE	CH1:47 V~57.6 V	I/P:230VAC(Δ) I/P:400VAC(Y) O/P:MIN. LOAD Ta:25°C	60.50V~45.11V /230VAC(Δ) 60.50V~45.10V/400VAC(Y)
2	OUTPUT VOLTAGE TOLERANCE	V1: -1%~ 1% (Max)	I/P: 196VAC /305VAC(Δ) I/P:340VAC /530VAC(Y) O/P: FULL LOAD / MIN. LOAD Ta:25°C	V1:0%~-0.27%(Δ) V1: 0%~-0.29%(Y)
3	LINE REGULATION	V1: -0.5%~ 0.5% (Max)	I/P: 196VAC~ 305VAC(Δ) I/P: 340VAC~ 530VAC(Y) O/P: FULL LOAD / MIN. LOAD Ta:25°C	V1:0 %~0%(Δ) V1:0 %~0%(Y)
4	LOAD REGULATION	V1: -0.5%~ 0.5% (Max)	I/P: 230VAC(Δ) I/P:400VAC(Y) O/P:FULL ~MIN LOAD Ta:25°C	V1:-0.04%~0.23%(Δ) V1:-0.06 %~0.22%(Y)
5	RIPPLE & NOISE	V1: 200mVp-p (Max)	I/P:230VAC(Δ) I/P:400VAC(Y) O/P:FULL LOAD Ta:25°C	V1: 125 mVp-p(Δ) V1: 120 mVp-p (Y)

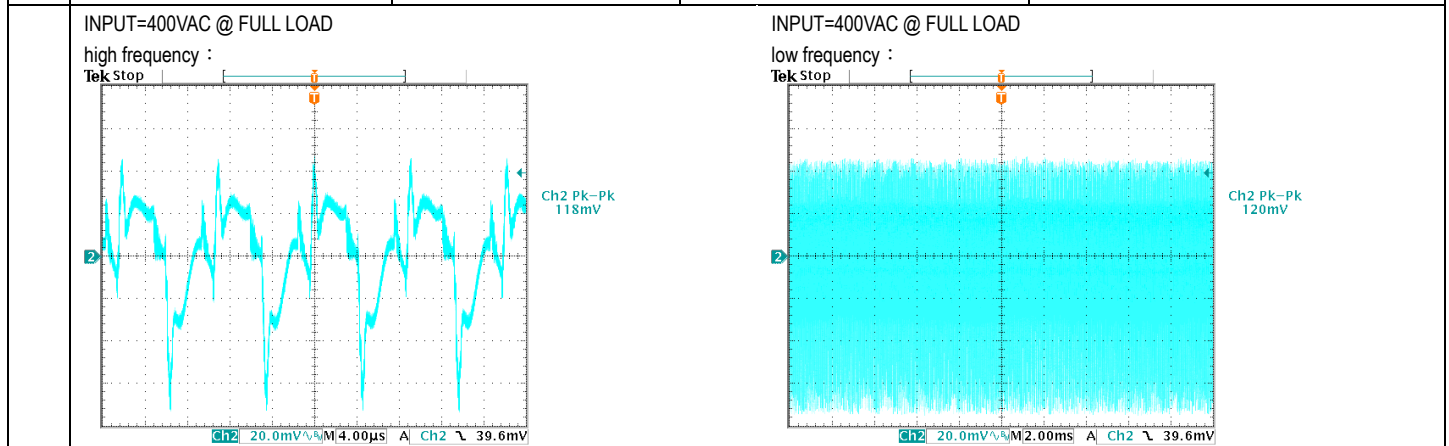

6	SET UP TIME	230VAC/220ms (Max) 400VAC/220ms (Max)	I/P: 230VAC(Δ) 400VAC(Y) O/P:FULL LOAD Ta:25°C	230VAC/1820 ms(Δ) 400VAC/ 1800ms(Y)
---	-------------	--	---	--

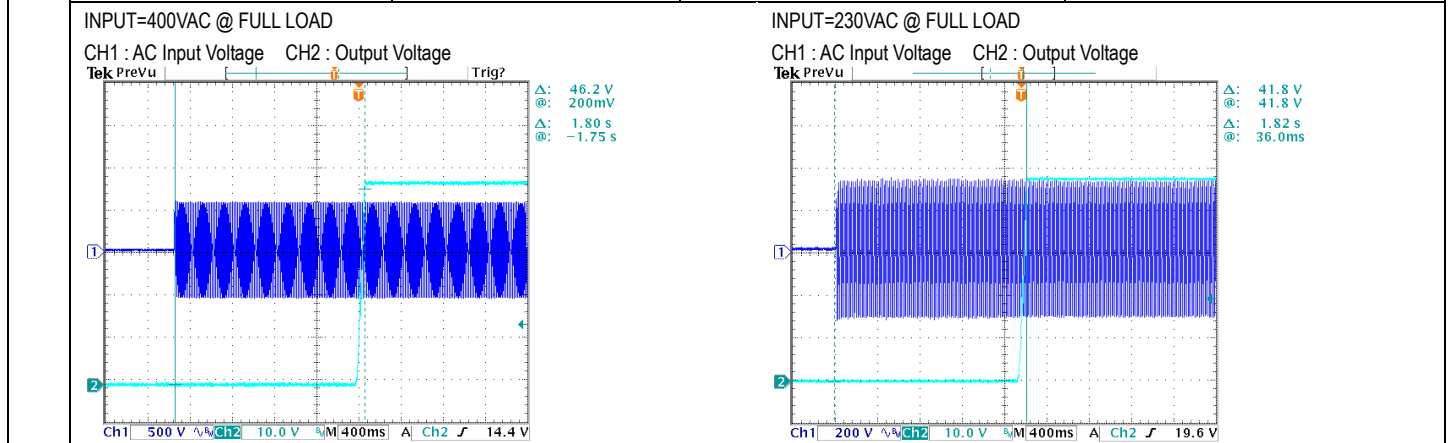



10000W Single Output Power Supply

RST-10000 series

7	RISE TIME	230VAC/80ms (Max) 400VAC/80ms (Max)	I/P: 230VAC(Δ) I/P: 400VAC(Y) O/P: FULL LOAD Ta:25°C	230VAC/46.8 ms(Δ) 400VAC/ 45.2ms(Y)
INPUT=400VAC @ FULL LOAD CH2 : Output Voltage Tek Run		INPUT=230VAC @ FULL LOAD CH2: Output Voltage Tek Stop		
8		230VAC/ 14ms (Typ.) 400VAC/ 14ms (Typ.)	I/P: 230VAC(Δ) FULL LOAD I/P:400VAC(Y) FULL LOAD	230VAC(Δ)/22ms 400VAC(Y)/22.4ms
		230VAC/ 20ms (Typ.) 400VAC/ 20ms (Typ.)	I/P: 230VAC(Δ) 75% LOAD I/P:400VAC(Y) 75% LOAD Ta:25°C	230VAC(Δ)/29.4ms 400VAC(Y)/29.4ms
INPUT=400VAC @ FULL LOAD CH1 : AC Input Voltage CH2 : Output Voltage Tek Run		INPUT=230VAC @ FULL LOAD CH1 : AC Input Voltage CH2 : Output Voltage Tek Stop		
9		V1:4800 mVp-p	I/P: 400VAC(Y) / 230VAC(Δ) O/P:	(1).1070mVp-p @400VAC 1080mVp-p @230VAC (2).1080mVp-p @400VAC 1210mVp-p @230VAC
(1).400VAC FULL /50% LOAD 50%DUTY / 120HZ Tek Stop		(2).400VAC FULL /50% LOAD 50%DUTY / 1KHZ Tek Stop		
Ch2 Pk-Pk 1.07 V		Ch2 Pk-Pk 1.08 V		

INPUT FUNCTION TEST

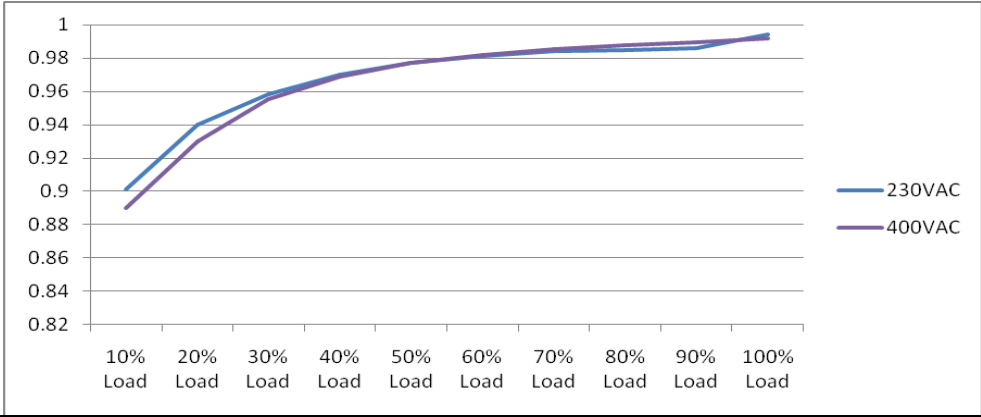
NO	TEST ITEM	SPECIFICATION	TEST CONDITION	RESULT
1	INPUT VOLTAGE RANGE	3Phase 3 Wire 196VAC~305VAC 3Phase 4 Wire 340VAC~530VAC	I/P: TESTING O/P: FULL LOAD Ta: 25°C	188.79V~305 V(Δ) 323.7V~530V(Y)
			I/P: (1) LOW-LINE-3V=193(Δ) / 337V(Y) HIGH-LINE+5V=305(Δ) / 535V(Y) O/P: FULL/MIN LOAD ON: 30 Sec OFF: 30 Sec 10MIN (2) 230(Δ)/400Vac(Y) ON: 0.5 Sec OFF: 0.5 Sec 20MIN (3) 230(Δ)/400Vac(Y) ON: 3Sec OFF: 3Sec 12HOURS (AC POWER ON/OFF NO DAMAGE)	TEST: OK
2	INPUT FREQUENCY RANGE	47HZ ~63 HZ NO DAMAGE OSC	I/P: 196 VAC ~305 VAC(Δ)/340~530VAC(Y) O/P: FULL-MIN LOAD Ta: 25°C	TEST: OK
3	POWER FACTOR(TYP)	0.95 / 230VAC(Δ) 0.95 / 400VAC(Y)	I/P: 230 VAC(Δ) I/P: 400VAC(Y) O/P: FULL LOAD Ta: 25°C	PF=0.994/230VAC(Δ) PF=0.99/400VAC(Y)
			P.F vs LOAD 	
4	EFFICIENCY (TYP)	91%	I/P: 230 VAC(Δ) I/P: 400VAC(Y) O/P: FULL LOAD Ta: 25°C	91.07%/230VAC (Δ) 91.26%/400VAC(Y)
			EFFICIENCY vs LOAD	



10000W Single Output Power Supply

RST-10000 series

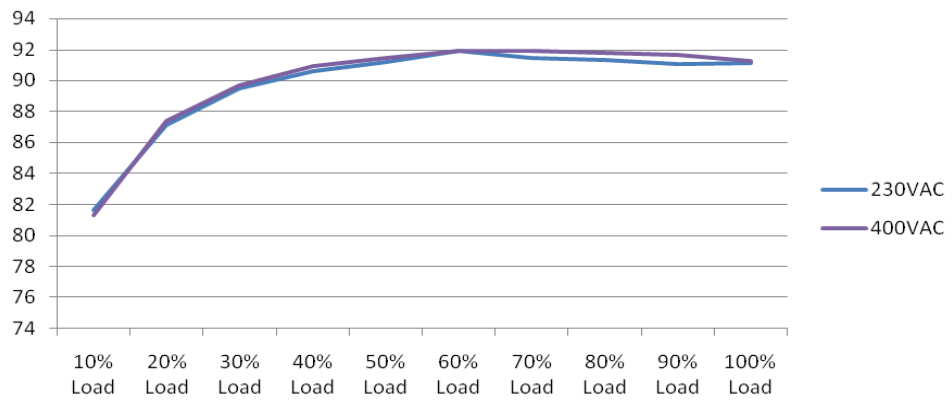

5	INPUT CURRENT (Typ)	230V (3Φ Δ)/ 30A 400V (3Φ Y)/ 18A	I/P: 230 VAC(Δ) I/P:400VAC(Y) O/P:FULL LOAD Ta:25°C	I =28.49 A/ 230VAC(Δ) I = 15.73A/ 400VAC(Y)
6	INRUSH CURRENT(Typ)	230V/150 A 400V/100 A COLD START	I/P:230VAC(Δ) I/P:400VAC (Y) O/P:FULL LOAD Ta:25°C	I =106A/230 VAC (Δ) I =68.5A/ 400VAC (Y)

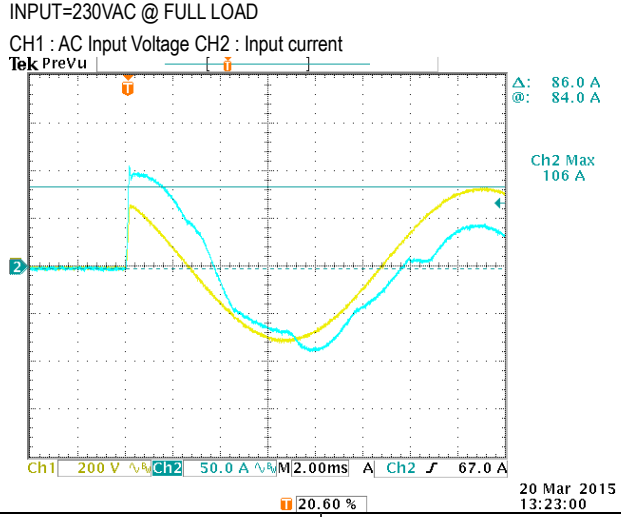
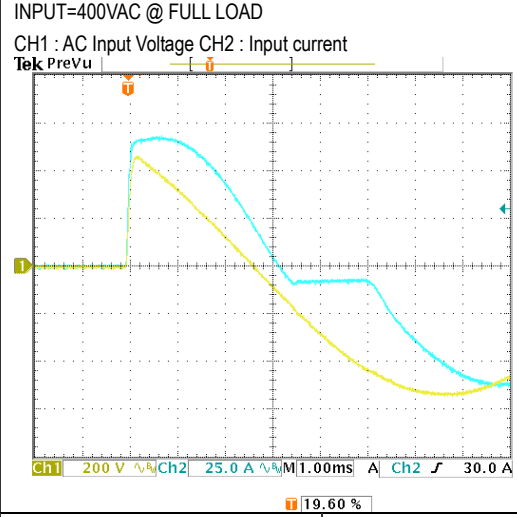

7	LEAKAGE CURRENT	<7mA /305V (Δ)	I/P:305VAC(Δ) O/P:NO LOAD Ta:25°C	R-FG:2.8mA S-FG:2.8mA T-FG:2.8mA R,S,T, -V(+):2mA R,S,T-V(-): 2mA
---	-----------------	----------------	---	---

PROTECTION FUNCTION TEST

NO	TEST ITEM	SPECIFICATION	TEST CONDITION	RESULT	VERDICT
1	OVER LOAD PROTECTION	100%~112%	I/P: 230VAC(Δ) I/P:400VAC(Y) O/P:TESTING Ta:25°C	105%/230VAC(Δ) 104.85%/400VAC(Y) User adjustable continuous constant current limiting or constant current limiting with delay shutdown after 5 seconds, re-power on to recover	P
2	OVER VOLTAGE PROTECTION	60V~67.2V	I/P: 230VAC(Δ) I/P:400VAC(Y) O/P: MIN LOAD Ta:25°C	63.2V/ 230VAC(Δ) 63.2V/400VAC(Y) Shunt down Re- power ON	P
3	OVER TEMPERATURE PROTECTION	Shut down o/p voltage · recovers automatically after temperature goes down	I/P: 230 VAC(Δ) I/P:400VAC(Y) O/P:FULL LOAD	Shut down o/p voltage · recovers automatically after temperature goes down	P
4	SHORT PROTECTION	SHORT EVERY OUTPUT 1 HOUR NO DAMAGE	I/P: 305VAC(Δ) I/P:530VAC(Y) O/P: FULL LOAD Ta:25°C	NO DAMAGE User adjustable continuous constant current limiting or constant current limiting with delay shutdown after 5 seconds, re-power on to recover	P

CONTROL FUNCTION TEST

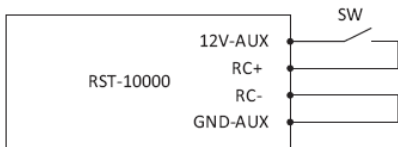
NO	TEST ITEM	SPECIFICATION	TEST CONDITION	RESULT						
1	AUXILIARY POWER (AUX)	12V@0.1A Only for Remote ON/OFF Control	I/P: 230 VAC(Δ) I/P: 400VAC(Y) O/P:FULL LOAD Ta:25°C	230 VAC(Δ):11.98 V0.1A 400VAC(Y):11.98V0.1A						
2	Remote ON/OFF Control	<p>The PSU can be turned ON/OFF by using the "Remote ON/OFF" function.</p> <table border="1"> <thead> <tr> <th>Between ON/OFF(CN313 or CN314 pin10) and 12V-AUX(CN315 pin1)</th> <th>Output Status</th> </tr> </thead> <tbody> <tr> <td>SW close (Short)</td> <td>PSU ON</td> </tr> <tr> <td>SW open (Open)</td> <td>PSU OFF</td> </tr> </tbody> </table>  <p>Fig 1.1</p>		Between ON/OFF(CN313 or CN314 pin10) and 12V-AUX(CN315 pin1)	Output Status	SW close (Short)	PSU ON	SW open (Open)	PSU OFF	
Between ON/OFF(CN313 or CN314 pin10) and 12V-AUX(CN315 pin1)	Output Status									
SW close (Short)	PSU ON									
SW open (Open)	PSU OFF									
3	REMOTE SENSE	S+ / S- >0.3V	I/P: 400VAC(Y) O/P:FULL LOAD Ta:25°C	> 0.3 V						

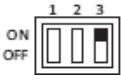
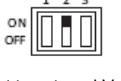
4	OUTPUT VOLTAGE PROGRAMMABLE	<p>I/P: 400VAC(Y)</p>  <p>DIP SW3 ON CN313 PV+ Connect to external V+ CN313 PV- Connect to external V-</p> <table border="1" data-bbox="446 436 901 660"> <thead> <tr> <th>EXT.DC(V)</th> <th>Vo(%)</th> <th>LOAD</th> </tr> </thead> <tbody> <tr><td>DC=1V±0.5%</td><td>20%±3%</td><td>0~100%</td></tr> <tr><td>DC=2V±0.5%</td><td>40%±3%</td><td>0~100%</td></tr> <tr><td>DC=3V±0.5%</td><td>60%±3%</td><td>0~100%</td></tr> <tr><td>DC=4V±0.5%</td><td>80%±3%</td><td>0~100%</td></tr> <tr><td>DC=5V±0.5%</td><td>100%±3%</td><td>0~100%</td></tr> <tr><td>DC=6V±0.5%</td><td>120%±3%</td><td>0~80%</td></tr> </tbody> </table>	EXT.DC(V)	Vo(%)	LOAD	DC=1V±0.5%	20%±3%	0~100%	DC=2V±0.5%	40%±3%	0~100%	DC=3V±0.5%	60%±3%	0~100%	DC=4V±0.5%	80%±3%	0~100%	DC=5V±0.5%	100%±3%	0~100%	DC=6V±0.5%	120%±3%	0~80%	<table border="1" data-bbox="997 380 1356 616"> <thead> <tr> <th>EXT.DC(V)</th> <th>Vo(%)</th> <th>LOAD</th> </tr> </thead> <tbody> <tr><td>DC=1V</td><td>20.5%~20.3%</td><td>0~100%</td></tr> <tr><td>DC=2V</td><td>40.02%~39.8%</td><td>0~100%</td></tr> <tr><td>DC=3V</td><td>60.08%~59.66%</td><td>0~100%</td></tr> <tr><td>DC=4V</td><td>81.07%~80.66%</td><td>0~100%</td></tr> <tr><td>DC=5V</td><td>99.71%~99.23%</td><td>0~100%</td></tr> <tr><td>DC=6V</td><td>119.3%~119.5%</td><td>0~80%</td></tr> </tbody> </table>	EXT.DC(V)	Vo(%)	LOAD	DC=1V	20.5%~20.3%	0~100%	DC=2V	40.02%~39.8%	0~100%	DC=3V	60.08%~59.66%	0~100%	DC=4V	81.07%~80.66%	0~100%	DC=5V	99.71%~99.23%	0~100%	DC=6V	119.3%~119.5%	0~80%
EXT.DC(V)	Vo(%)	LOAD																																											
DC=1V±0.5%	20%±3%	0~100%																																											
DC=2V±0.5%	40%±3%	0~100%																																											
DC=3V±0.5%	60%±3%	0~100%																																											
DC=4V±0.5%	80%±3%	0~100%																																											
DC=5V±0.5%	100%±3%	0~100%																																											
DC=6V±0.5%	120%±3%	0~80%																																											
EXT.DC(V)	Vo(%)	LOAD																																											
DC=1V	20.5%~20.3%	0~100%																																											
DC=2V	40.02%~39.8%	0~100%																																											
DC=3V	60.08%~59.66%	0~100%																																											
DC=4V	81.07%~80.66%	0~100%																																											
DC=5V	99.71%~99.23%	0~100%																																											
DC=6V	119.3%~119.5%	0~80%																																											
5	OUTPUT CURRENT PROGRAMMABLE	<p>I/P: 400VAC(Y)</p>  <p>DIP SW2 ON CN313 PC+ Connect to external V+ CN313 PC- Connect to external V-</p> <table border="1" data-bbox="446 862 901 1064"> <thead> <tr> <th>EXT.DC(V)</th> <th>Io_limit (%)</th> <th>LOAD</th> </tr> </thead> <tbody> <tr><td>DC=1V±0.5%</td><td>20%±10%</td><td>0~100%</td></tr> <tr><td>DC=2V±0.5%</td><td>40%±10%</td><td>0~100%</td></tr> <tr><td>DC=3V±0.5%</td><td>60%±10%</td><td>0~100%</td></tr> <tr><td>DC=4V±0.5%</td><td>80%±10%</td><td>0~100%</td></tr> <tr><td>DC=5V±0.5%</td><td>100%±10%</td><td>0~100%</td></tr> </tbody> </table>	EXT.DC(V)	Io_limit (%)	LOAD	DC=1V±0.5%	20%±10%	0~100%	DC=2V±0.5%	40%±10%	0~100%	DC=3V±0.5%	60%±10%	0~100%	DC=4V±0.5%	80%±10%	0~100%	DC=5V±0.5%	100%±10%	0~100%	<table border="1" data-bbox="997 784 1412 985"> <thead> <tr> <th>EXT.DC(V)</th> <th>Io_limit (%)</th> <th>LOAD</th> </tr> </thead> <tbody> <tr><td>DC=1V</td><td>20.90%</td><td>0~100%</td></tr> <tr><td>DC=2V</td><td>41.23%</td><td>0~100%</td></tr> <tr><td>DC=3V</td><td>60.52%</td><td>0~100%</td></tr> <tr><td>DC=4V</td><td>80.23%</td><td>0~100%</td></tr> <tr><td>DC=5V</td><td>100.57%</td><td>0~100%</td></tr> </tbody> </table>	EXT.DC(V)	Io_limit (%)	LOAD	DC=1V	20.90%	0~100%	DC=2V	41.23%	0~100%	DC=3V	60.52%	0~100%	DC=4V	80.23%	0~100%	DC=5V	100.57%	0~100%						
EXT.DC(V)	Io_limit (%)	LOAD																																											
DC=1V±0.5%	20%±10%	0~100%																																											
DC=2V±0.5%	40%±10%	0~100%																																											
DC=3V±0.5%	60%±10%	0~100%																																											
DC=4V±0.5%	80%±10%	0~100%																																											
DC=5V±0.5%	100%±10%	0~100%																																											
EXT.DC(V)	Io_limit (%)	LOAD																																											
DC=1V	20.90%	0~100%																																											
DC=2V	41.23%	0~100%																																											
DC=3V	60.52%	0~100%																																											
DC=4V	80.23%	0~100%																																											
DC=5V	100.57%	0~100%																																											
6	Select OLP mode	<table border="1" data-bbox="606 1108 1348 1198"> <thead> <tr> <th>SW301</th> <th>PROTECTION</th> </tr> </thead> <tbody> <tr> <td>SW970 PIN1 ON</td> <td>Constant current delay 5sec Vo shutdown repower on</td> </tr> <tr> <td>SW970 PIN1 OFF</td> <td>Constant current</td> </tr> </tbody> </table>		SW301	PROTECTION	SW970 PIN1 ON	Constant current delay 5sec Vo shutdown repower on	SW970 PIN1 OFF	Constant current																																				
SW301	PROTECTION																																												
SW970 PIN1 ON	Constant current delay 5sec Vo shutdown repower on																																												
SW970 PIN1 OFF	Constant current																																												
7	Front Panel Indicators	<table border="1" data-bbox="446 1232 949 1332"> <thead> <tr> <th>LED</th> <th>Description</th> </tr> </thead> <tbody> <tr> <td>GREEN(LED1)</td> <td>LED on when output voltage is OK</td> </tr> <tr> <td>RED(LED2)</td> <td>LED on when any protection occurs</td> </tr> </tbody> </table>		LED	Description	GREEN(LED1)	LED on when output voltage is OK	RED(LED2)	LED on when any protection occurs																																				
LED	Description																																												
GREEN(LED1)	LED on when output voltage is OK																																												
RED(LED2)	LED on when any protection occurs																																												
8	FAN LOCK TEST	<p>I/P: 400VAC(Y) O/P: FULL LOAD Ta: 25°C</p>	Shut down Re-power ON																																										
9	AC- FAIL	<p>I/P: 400VAC(Y) O/P: NO LOAD</p> <table border="1" data-bbox="446 1534 941 1624"> <thead> <tr> <th>Test condition</th> <th>Input Voltage</th> <th>STATE</th> </tr> </thead> <tbody> <tr> <td>Low Line</td> <td>316±7Vac(Y)</td> <td>AC Fail</td> </tr> <tr> <td>Low Line recovery</td> <td>332±5Vac(Y)</td> <td>OK</td> </tr> </tbody> </table> <p>Ta: 25°C</p>	Test condition	Input Voltage	STATE	Low Line	316±7Vac(Y)	AC Fail	Low Line recovery	332±5Vac(Y)	OK	<table border="1" data-bbox="981 1478 1380 1624"> <thead> <tr> <th>Test condition</th> <th>Input Voltage</th> <th>STATE</th> </tr> </thead> <tbody> <tr> <td>Low Line</td> <td>314.7</td> <td>AC Fail</td> </tr> <tr> <td>Low Line recovery</td> <td>332.72</td> <td>OK</td> </tr> </tbody> </table>	Test condition	Input Voltage	STATE	Low Line	314.7	AC Fail	Low Line recovery	332.72	OK																								
Test condition	Input Voltage	STATE																																											
Low Line	316±7Vac(Y)	AC Fail																																											
Low Line recovery	332±5Vac(Y)	OK																																											
Test condition	Input Voltage	STATE																																											
Low Line	314.7	AC Fail																																											
Low Line recovery	332.72	OK																																											
10	CURRENT SHARING	<p>PSU1-PSU2 < 10%</p>	<p>I/P: 400VAC(Y) O/P : 90%/L/50% LOAD Ta : 25°C</p> <p>O/P : 100% PSU1 : 213.5 A PSU2 : 209.3 A</p> <p>O/P : 50% PSU1 : 106.5 A PSU2 : 104.2 A</p>																																										
11	Alarm Signal Output	<p>There are 4 alarm signals on CN315, and each signal can select two types of output circuit. (1)Relay contact output Normally open contact. "Short" when the alarm arises. Relay contact rating(maximum) is 30V/1A resistive.</p>																																											

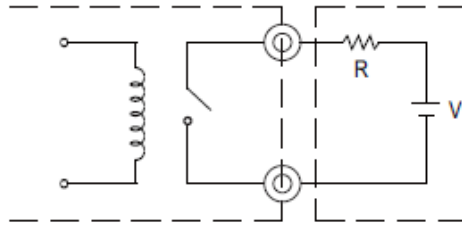

(2)Open collector output

Normally open contact. "Short" when the alarm arises. Relay contact rating(maximum) is 30V/1A resistive.

An external voltage source is required for this function that is shown in Fig 7.2. These signals are isolated from output. The maximum sink current is 10mA and the maximum external voltage is 20V (there is a built-in 24V zener diode in inner circuitry).

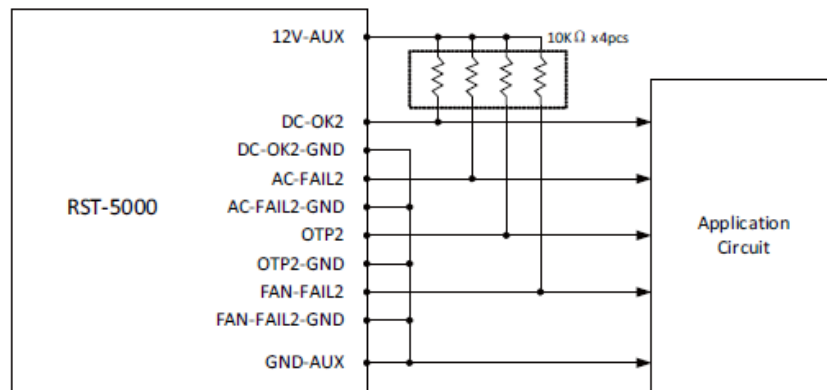

TEST CONDITION :

I/P: 400VAC(Y)
O/P:FULL LOAD
Ta:25°C

RESULT:

Function	Description
DC- OK 1: AC-FAIL 1 FAN -FAIL 1 OTP 1	Alarm signal of AC-fail. Normally open contact. "Short" when the PSU input voltage is too low. Relay contact rating(maximum) is 30V/1A resistive.
DC- OK 2: AC-FAIL 2 FAN -FAIL 2 OTP 2	Alarm signal of AC fail. Open collector signal. Low when the PSU input voltage is too low. The maximum sink current is 10mA and the maximum external voltage is 20V.

COMPONENT STRESS TEST

NO	TEST ITEM	SPECIFICATION	TEST CONDITION	RESULT
1	PWM Transistor (D to S) or (C to E) Peak Voltage	Q124 Rated 36 A/500V	I/P:High-Line =533V(Y) O/P: (1)Full Load input on/off (2)Output Short (3)Dynamic Load Full Load/ Min. Load 90%Duty/1KHz Ta:25°C	(1)428V (2)454V (3)446V

2	Diode Peak Voltage	D452 Rated 200A/200V	I/P:High-Line =533 V (Y) O/P: (1)Full Load input on/off (2)Output Short (3)Dynamic Load Full Load/ Min. Load 90%Duty/1KHz Ta:25°C	(1)172V (2)142V (3)173V
3	Input Capacitor Voltage	C2 Rated: 470μ /450 SURGE VOLTAGE :495V	I/P:High-Line =533 V (Y) O/P: (1)Full Load input on/off (2) Min load input on /Off (3)Full Load /Min load Change Ta:25°C	(1)462V (2)460V (3)450V
4	Control IC Voltage Test	U302 Rated 9.8~18.5V	I/P:High-Line =533 V (Y) O/P:(1)FULL LOAD (2) Output Short Ta:25°C	(1)12.8V (2)12.4V
5	P.F.C Transistor (D to S) or (C to E) Peak Voltage	Q2 Rated 47A/ 600V	I/P:High-Line =533 V (Y) O/P: (1)Full Load input on/off (2)Output Short (3)Dynamic Load Full Load/ Min. Load 90%Duty/1KHz Ta:25°C	(1)544 V (2)530 V (3)506 V

SAFETY & E.M.C. TEST

SAFETY TEST

NO	TEST ITEM	SPECIFICATION	TEST CONDITION	RESULT
1	WITHSTAND VOLTAGE	I/P-O/P : 3 KVAC/min I/P-FG : 2KVAC/min O/P-FG : 0.5 KVAC/min	I/P-O/P : 3.6 KVAC/min I/P-FG : 2.4KVAC/min O/P-FG : 0.6 KVAC/min Ta : 25°C	I/P-O/P : 28.63 mA I/P-FG : 22.54 mA O/P-FG : 12.6 mA NO DAMAGE
2	ISOLATION RESISTANCE	I/P-O/P : 500VDC>100MΩ I/P-FG : 500VDC>100MΩ O/P-FG : 500VDC>100MΩ	I/P-O/P : 500 VDC I/P-FG : 500 VDC O/P-FG : 500 VDC Ta : 25°C /70%RH	I/P-O/P : 160 MΩ I/P-FG : 10.6 GΩ O/P-FG : 11.5 GΩ NO DAMAGE
3	GROUNDING CONTINUITY	FG(PE) TO CHASSIS OR TRACE < 100 mΩ	40 A / 2min Ta : 25°C / 70%RH	6 mΩ

E.M.C TEST

NO	TEST ITEM	SPECIFICATION	TEST CONDITION	RESULT
1	HARMONIC	EN61000-3-2 CLASS A	I/P: 400VAC(50HZ) (Y) O/P:100%,LOAD Ta:25°C	PASS
2	CONDUCTION	EN55022 CLASS A	I/P: 400VAC(50HZ) (Y) O/P:FULL/50% LOAD Ta:25°C	Test by certified Lab
3	RADIATION	EN55022 CLASS A	I/P: 400VAC(50HZ) (Y) O/P:FULL LOAD Ta:25°C	Test by certified Lab



4	E.S.D	EN61000-4-2 INDUSTRY AIR:8KV / Contact:4KV	I/P: 400VAC(50HZ) (Y) O/P:FULL LOAD Ta:25°C	CRITERIA A
5	E.F.T	EN61000-4-4 INDUSTRY INPUT: 2KV	I/P: 400VAC(50HZ) (Y) O/P:FULL LOAD Ta:25°C	CRITERIA A
6	SURGE	IEC61000-4-5 INDUSTRY L-N :2KV L,N-PE:4KV	I/P: 400VAC(50HZ) (Y) O/P:FULL LOAD Ta:25°C	CRITERIA A
7	Test by certified Lab & Test Report Prepare			

■ RELIABILITY TEST

ENVIRONMENT TEST

NO	TEST ITEM	SPECIFICATION	TEST CONDITION	RESULT
1	TEMPERATURE RISE TEST	MODEL : RST-10000-24 1. ROOM AMBIENT BURN-IN : 2 HRS I/P : 400VAC(Y) O/P : FULL LOAD Ta= 38 °C 2. HIGH AMBIENT BURN-IN : 2 HRS I/P : 400VAC(Y) O/P : FULL LOAD Ta= 48 °C		

		NO	Position	ROOM AMBIENT Ta= 38 °C	HIGH AMBIENT Ta= 48 °C
		1	Q151	68.8°C	80.5°C
		2	Q126	67.8°C	79.0°C
		3	D3	75.5°C	85.6°C
		4	D43	83.6°C	93.4°C
		5	Q3	73.0°C	83.5°C
		6	Q43	84.9°C	94.0°C
		7	BD1	87.4°C	97.4°C
		8	BD41	93.9°C	103.3°C
		9	L1	58.2°C	68.6°C
		10	C1	55.0°C	65.0°C
		11	T123	57.8°C	66.5°C
		12	L121	73.6°C	84.9°C
		13	D452	106.4°C	115.2°C
		14	NTC	57.4°C	67.8°C
		15	T451	88.1°C	99.3°C
		16	T452	92.2°C	102.1°C
		17	T453	80.8°C	91.9°C
		18	D456	58.4°C	68.9°C
		19	L452	69.1°C	80.9°C
		20	Q640	46.5°C	56.7°C
		21	C647	43.2°C	61.2°C
		22	C602	52.8°C	62.6°C
		23	C621	54.6°C	64.9°C
		24	RG603	57.4°C	79.2°C
		25	D148	62.1°C	74.3°C
		26	C122	56.4°C	66.8°C
		27	C146	57.0°C	67.4°C
		28	TSW1	75.2°C	85.1°C
		29	C465	58.5°C	69.6°C
2	OVER LOAD BURN-IN TEST	NO DAMAGE 1 HOUR (MIN)		I/P : 400VAC(Y) O/P : 104 % LOAD Ta : 25°C	TEST : OK
3	LOW TEMPERATURE TURN ON TEST	TURN ON AFTER 2 HOUR		I/P : 230VAC/196VAC(Δ) O/P : 100 % LOAD Ta= -35 °C	TEST : OK
4	HIGH HUMIDITY HIGH TEMPERATURE HIGH VOLTAGE TURN ON TEST	AFTER 12 HOURS IN CHAMBER ON CONTROL 50 °C NO DAMAGE		I/P : 540VAC(Δ) O/P : FULL LOAD Ta= 50 °C HUMIDITY= 95 %R.H	TEST : OK
5	TEMPERATURE COEFFICIENT	± 0.03 %(0~50°C)		I/P : 230 VAC(Δ) O/P : FULL LOAD	± 0.022 %(0~50°C)
6	STORAGE TEMPERATURE TEST	1. Thermal shock Temperature : -45°C~ +90°C 2. Temperature change rate : 25°C / MIN 3. Dwell time low and high temperature : 30 MIN/EACH 4. Total test cycle : 5 CYCLE 5. Input/Output condition : STATIC			OK



7	THERMAL SHOCK TEST	1. Thermal shock Temperature : -35°C ~ +55°C 2. Temperature change rate : 25°C / MIN 3. Dwell time low and high temperature : 30 MIN/EACH 4. Total test cycle : 10 CYCLE 5. Input/Output condition : 230VAC(Δ)/Full Load	OK
8	VIBRATION TEST	1 Carton & 1 Set (1) Waveform : Sine Wave (2) Frequency : 10~500Hz (3) Sweep Time : 12min/sweep cycle (4) Acceleration : 2G (5) Test Time : 60min in each axis (X.Y.Z) (6) Ta : 25°C	TEST : OK
9	CAPACITOR LIFE CYCLE	SUPPOSE C453 IS THE MOST CRITICAL COMPONENT (1) I/P : 400VAC(Y) O/P : FULL LOAD Ta= 25 °C LIFE TIME (2) I/P : 400VAC(Y) O/P : FULL LOAD Ta= 50 °C LIFE TIME (3) I/P : 400VAC(Y) O/P : 75% LOAD Ta= 50 °C LIFE TIME (4) I/P : 400VAC(Y) O/P : 50% LOAD Ta= 50 °C LIFE TIME	(1) 1844214 HRS (2) 306284 HRS (3) 384999 HRS (4) 433136 HRS
10	MTBF	Conducted by Parts Stress Analysis Prediction 50K hrs min. Telcordia SR-332 (Bellcore) ; 17K hrs min. MIL-HDBK-217F (25°C)	
11	DMTBF/Accelerated Life Test	Demonstration Mean Time Between Failure (Expected Life): Above 50,000 hours @ TA 50°C	

SAMPLE	TESTER	REVIEW	APPROVAL
Product sample	DANIEL GAO	SANFORD SU	VINCENT ZENG

12.10.30 A50-F031